

Round/ rectangular plate Type A

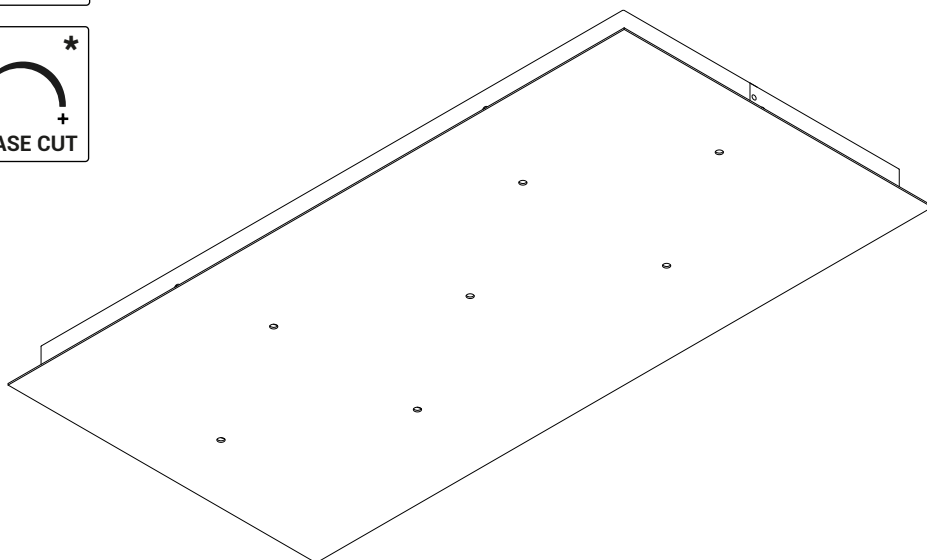

Round/rectangular plate Type A

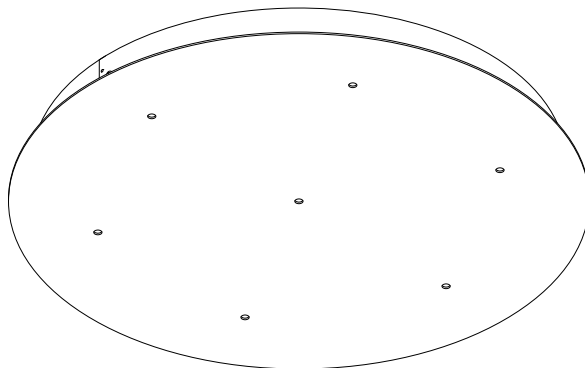
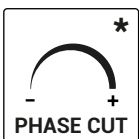
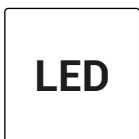
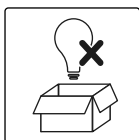
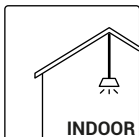
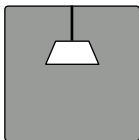
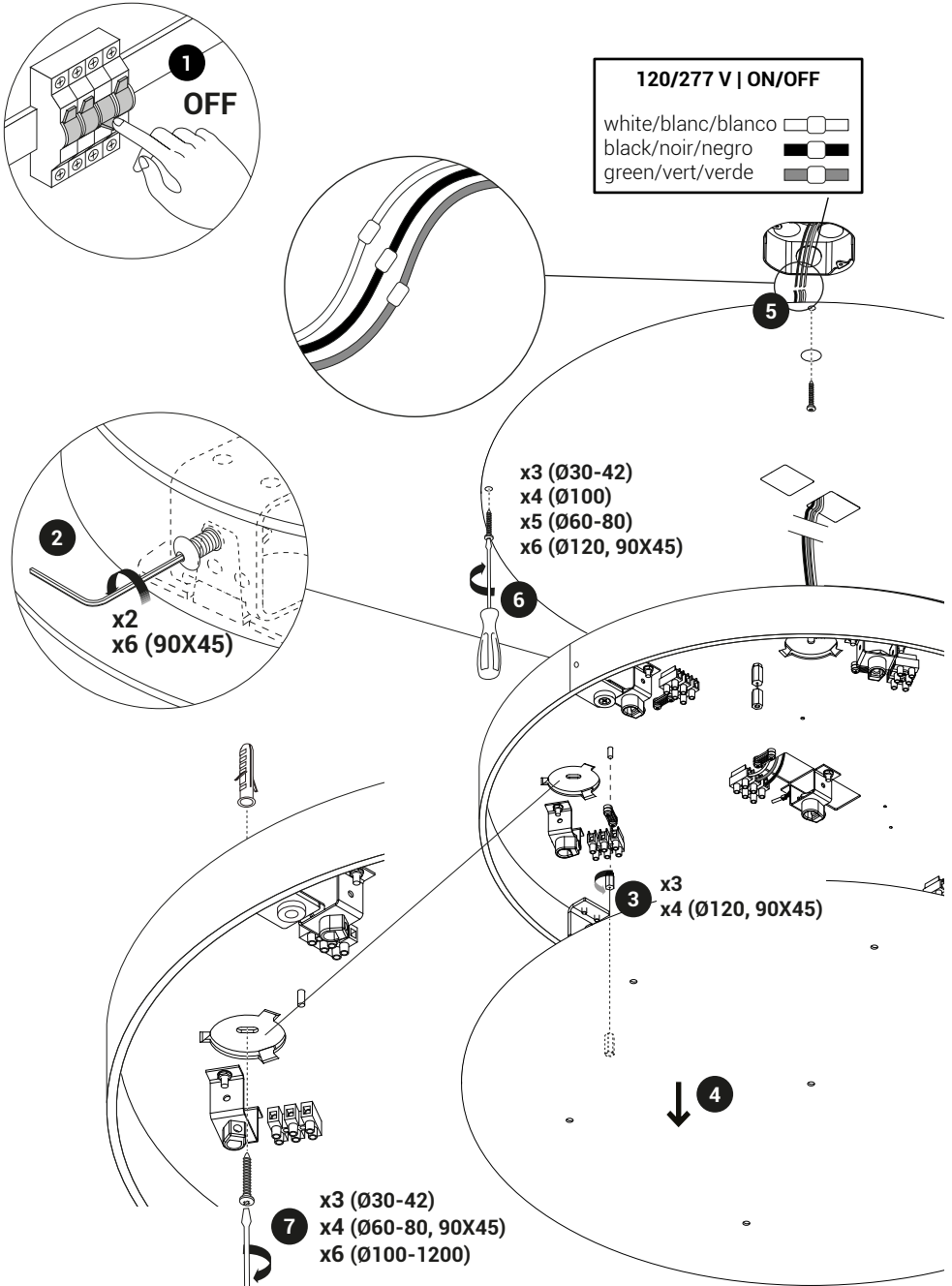

Round/rectangular plate Type A

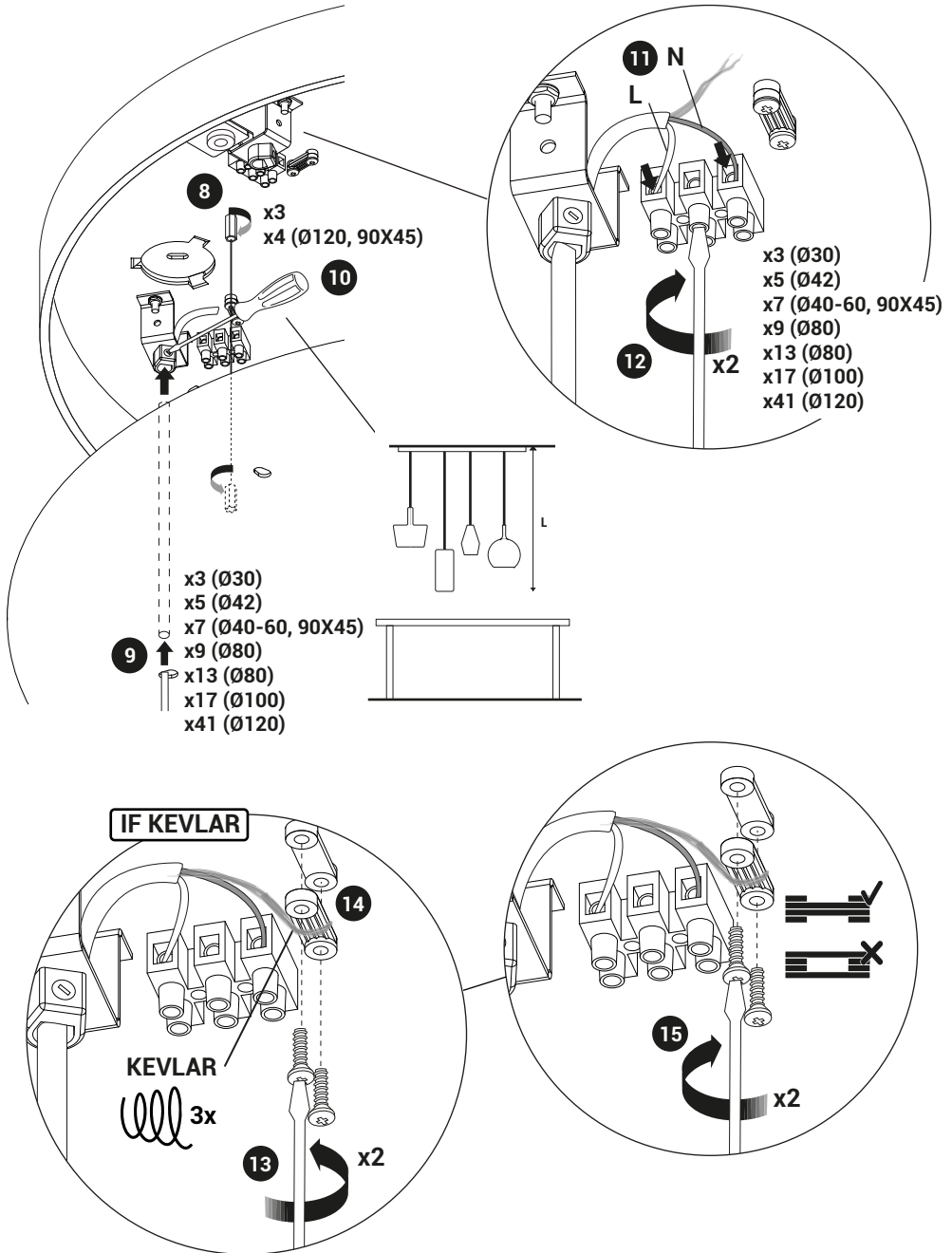

Round/rectangular plate Type A

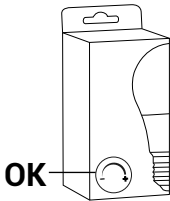
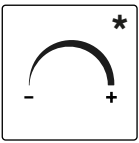
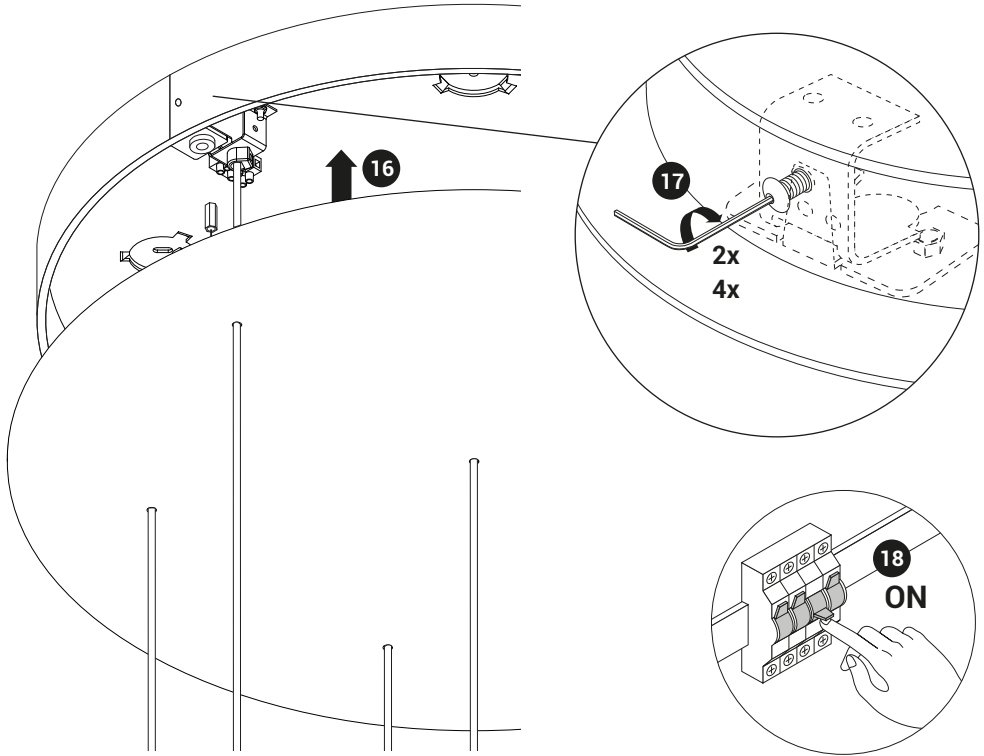

To inspect the electrical connections, remove the illuminated part from the mounting plate leaving it attached to the steel cables.

Pour inspecter les connexions électriques, enlevez la partie éclairée de la platine de montage en la laissant attachée aux câbles en acier.

For the electrical data refer to the product label data plate.

Pour les données électriques, se référer à la plaque signalétique du produit.

IMPORTANT: If the pendant wiring is replaced outside the manufacturing facility, UL Listed fixtures will lose their certification.

IMPORTANT: Si le câblage suspendu est remplacé à l'extérieur de l'usine de fabrication, les luminaires homologués UL perdront leur certification.

IST005024/D